

PRODUCT SHEET / 2019 01 04

LimbusFloor Glass

Write Board

Design: Team Glimakra



LimbusFloor Glass

Write Board

Design: Team Glimakra

LimbusFloor Glass is a floor screen with magnetic glass. Easy moveable with white feet on wheels. Choose color-matched glass for 8 different fabrics or white glass to any fabric. The floor screen has a perfect balance between sound absorption and sound propagation that is achieved with a sound reducing body and a sound absorbing polyether on both sides.

DIMENSIONS

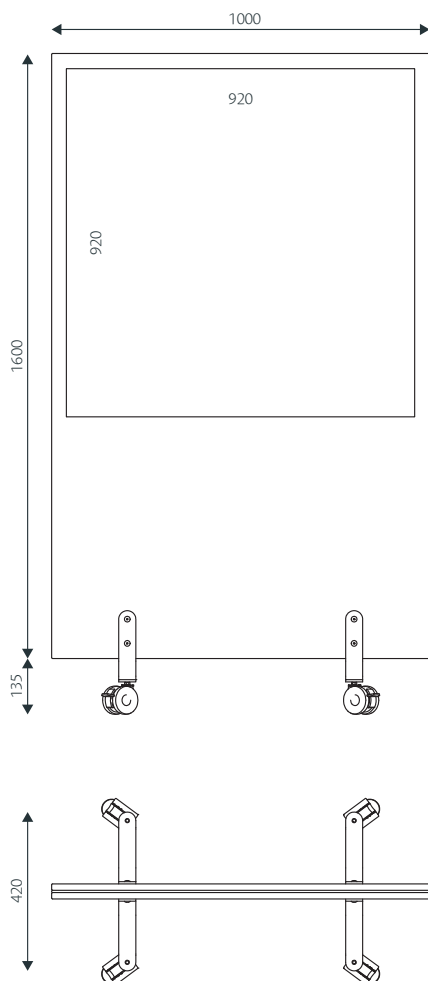

Size: 1000 x 1600mm (1735mm including wheels)

Weight: 30 kg

100% recyclable materials.

DESCRIPTION

Body: 15mm sound absorbing polyether (Oeko-Tex) glued on both sides of an 8mm sound reducing MDF board (Nordic Ecolabel) with a 40mm straight frame. Painted magnetic writing board in glass.

Upholstery: Upholstered with fabric on both sides. The nails are covered with a decorative fabric piping.

Foot with wheels: Powder coated white 190 x 45 x 6 mm.

Total height foot with wheels: 135 mm.

Installation: The feet are mounted with an allen key.

LimbusFloor Glass

Write Board

Design: Team Glimakra

FABRIC AND PIPING

Look in Product sheet Fabric and piping.pdf for our standard fabrics, you can download it here: <http://glimakra.com/en/download/>.

OPTIONS

Fabrics with colour matching glass typewriter: Mainline Flax 08, 09, 20, 21, 26, 28, 30, 31.

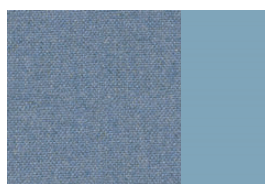

MLF 21

3020-B



MLF 09

4020-G10Y

2005-Y40R

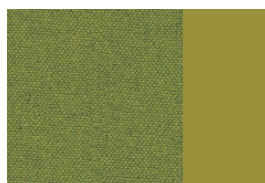

MLF 30

4040-G80Y

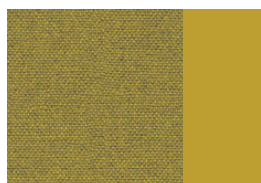

MLF 31

3060-Y

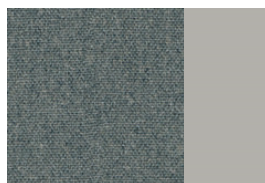

MLF 26

3502-Y

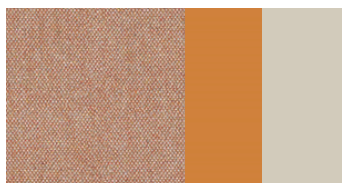

26 MLF 08

3050-Y40R

2005-Y40R

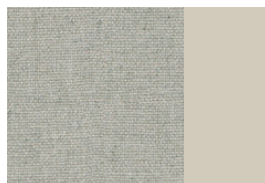

MLF 20

2005-Y40R

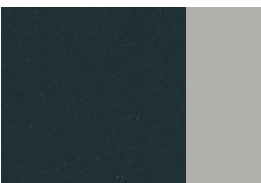

MLF 28

3502-Y

CERTIFICATES

Acoustics: Measurements made in accordance with ISO 354:2003. Evaluation made according to standards for individual objects SS 25269:2013 (Report 10171560.03, Date 2012-01-30, WSP Akustik, laboratory accredited by Swedac)

Möbelfakta: The product meets the requirements for environment and social responsibility defined by Möbelfakta.

Glimakra of Sweden AB is certified according to ISO 9001:2015 and ISO 14001:2015.



SPECIFICATION TEXT

E.g: LimbusFloor Glass 1000 x 1600 x 40 mm with white wheels. Magnetic colour matched writing board in glass. Fabric Mainline Flax 21, piping 57 beige. 2 x 15 mm sound absorbing polyether on both sides of an 8 mm sound reducing MDF board. Sharp corners.

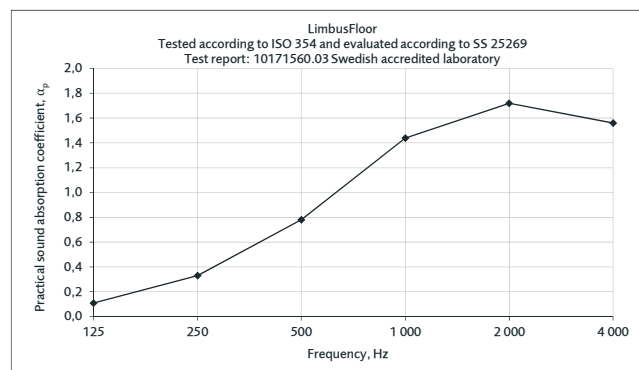

Equivalent absorption area per m² screen surface (m²S/m²)

The values are to be multiplied by the screen area.

LimbusFloor Glass

Write Board

Design: Team Glimakra

