

Global

Wall absorbent

Design: Team Glimakra

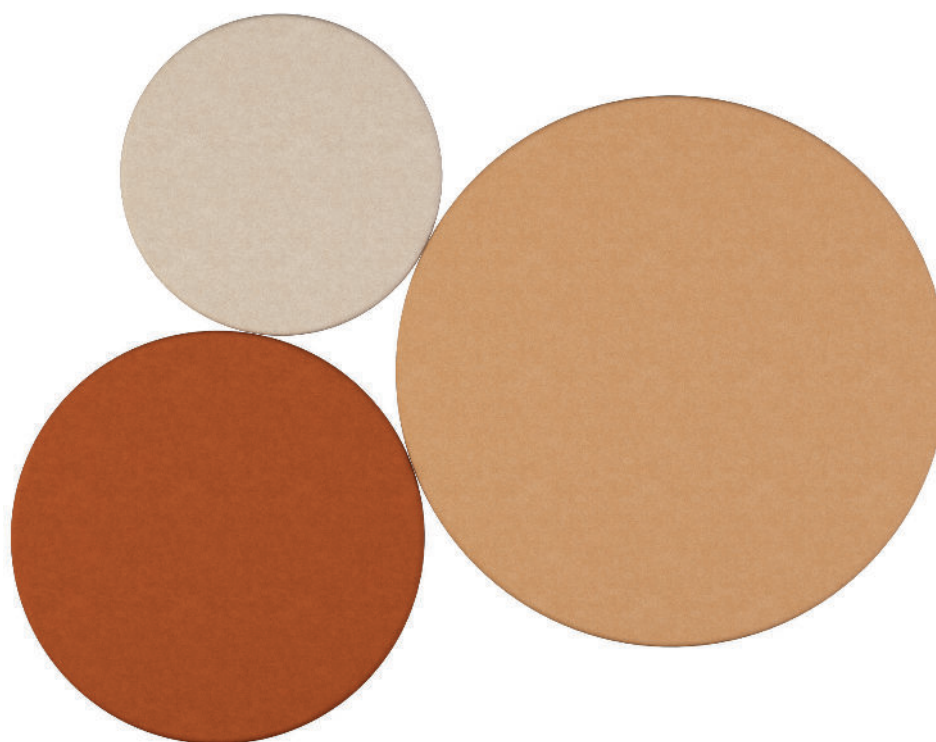

Global

Wall absorbent

Design: Team Glimakra

Global is a high-absorbing wall absorbent with rounded borders and shapes. The fabric is nailed to the solid body with high quality and precision. The large selection of standard fabrics provide almost unlimited opportunities to create beautiful and functional wall environments. The panels are easy to install using aluminum rails screwed to the wall. Global is available in three round and three square standard sizes and also in special dimensions.

DIMENSIONS

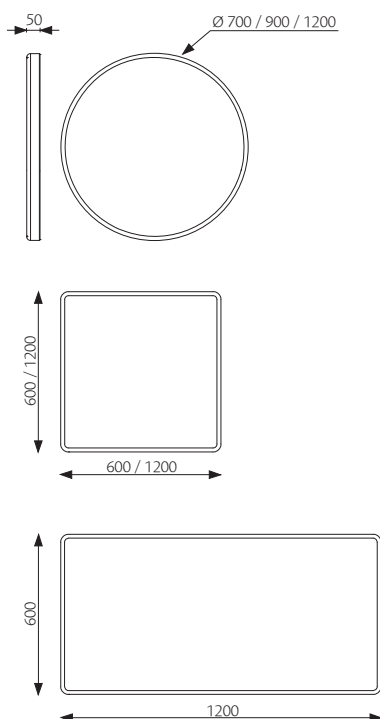

Other dimensions on request.

Thickness: 50 mm

Weight square: 6 / 9 / 15 kg

Weight round: 7 / 9 / 12 kg

DESCRIPTION

Body: 40 mm polyether (Oeko-Tex) glued on 8 mm MDF board (Nordic Ecolabel).

Upholstery: Upholstered with fabric. The nails are covered with a plastic profile.

Installation: Mounting with aluminum rails screwed to the wall.



100 % recyclable materials.

FABRIC AND PIPING

Look in Product sheet Fabric and piping.pdf for our standard fabrics, you can download it here: <http://glimakra.com/en/download/>.

OPTIONS

Plastic profile: Black, white and grey.

Installation: Alternative mounting with panel click button connectors, e.g. when sloping walls.

Global

Wall absorbent

Design: Team Glimakra



CERTIFICATES

Acoustics: Measurements made in accordance with ISO 354:2003. Evaluation made according to standards for individual objects SS 25269:2013, 2015-12-26, and ISO 11654:1997. (Report 10171560.02, Date 2013-01-04, WSP Akustik)

Möbelfakta: This product has been declared and approved according to the criteria of Möbelfakta ver. 2019-05-01. Reg. number 0120160127. Validity: until 2026-01-27.



Glimakra of Sweden AB is certified according to ISO 9001:2015 and ISO 14001:2015.



SPECIFICATION TEXT

E.g: Glimakra Global 1200 x 1200 mm.
Fabric: Blazer CUZ28. Plastic profile: Black
Installation with aluminum rails for easy wall mounting.
Acoustics evaluated according to SS 25269.
Meet the criteria of Möbelfakta.

Global

Wall absorbent

Design: Team Glimakra

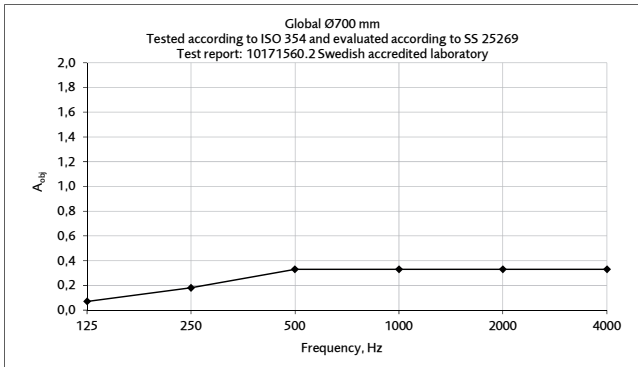

Equivalent absorption area per object (m²S/object)

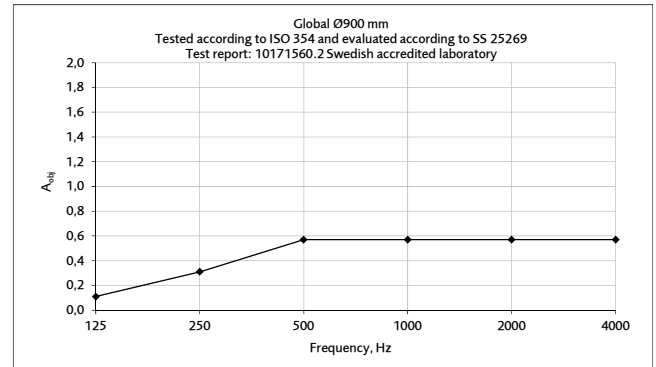

Equivalent absorption area per object (m²S/object)

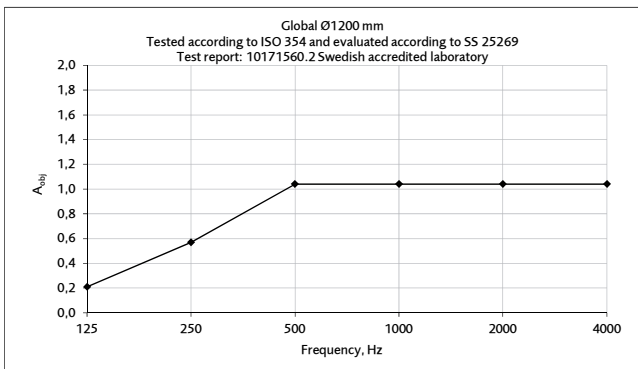

Equivalent absorption area per object (m²S/object)

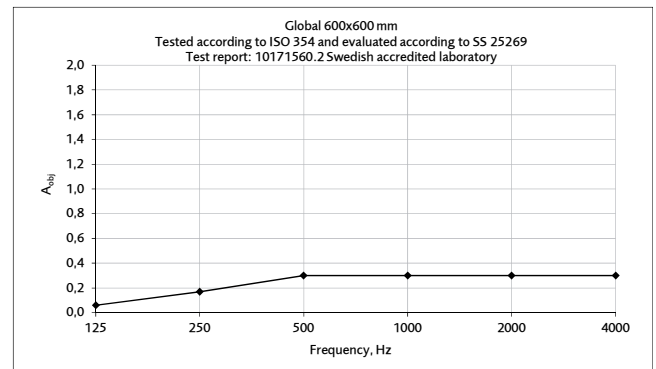

Equivalent absorption area per object (m²S/object)

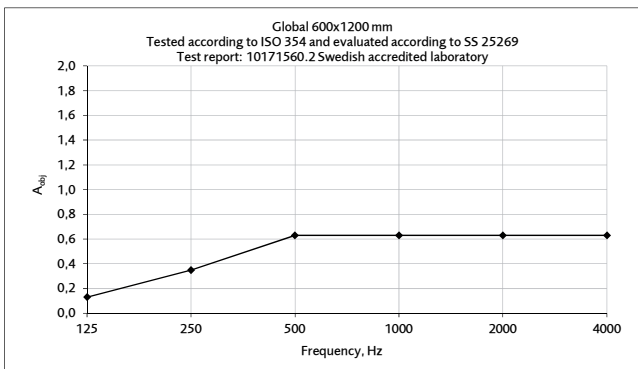

Equivalent absorption area per object (m²S/object)

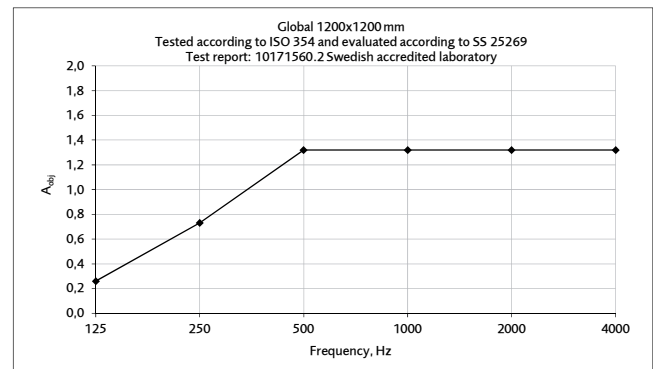

Equivalent absorption area per object (m²S/object)

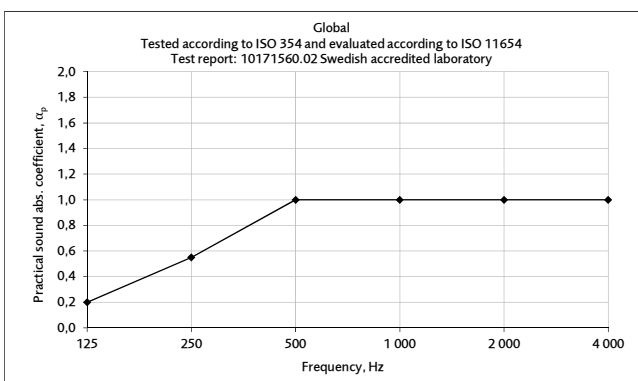

Equivalent absorption area per m² screen surface (m²S/m²)

Global

Wall absorbent

Design: Team Glimakra

