

LimbusBuildup

Partitions

Design: Johan Kauppi



LimbusBuildup

Partitions

Design: Johan Kauppi

LimbusBuildup is a fabric-covered partition wall system with the same high quality and sound comfort that Glimakra of Sweden is known for. The system can be varied in endless combinations with different corners, fittings, accessories and colours. With LimbusBuildup quiet soundscapes can be created with open or closed rooms, creative pavilions or freestanding walls. The walls can be equipped with doors and also lighting niches and windows that can be placed orderly or in a more playful way, if desired. The windows are available with clear or frosted glass or completely open where the shelf can be used for storage or exposure of objects and plants.

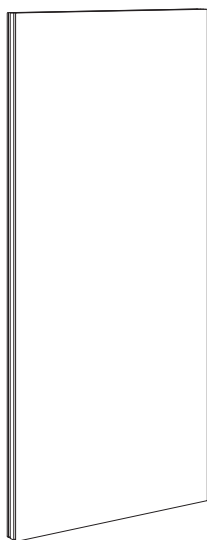

Screen, straight
Thickness: 80 mm

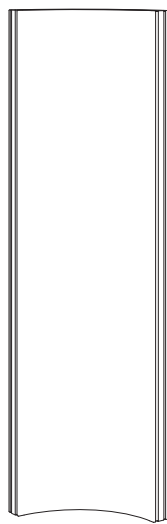

Screen, curved

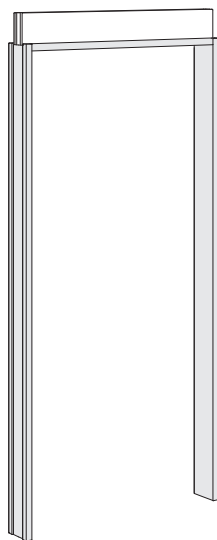

Frame
140 mm

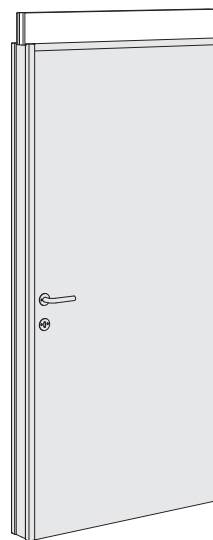

Door, right alt. left-hinged

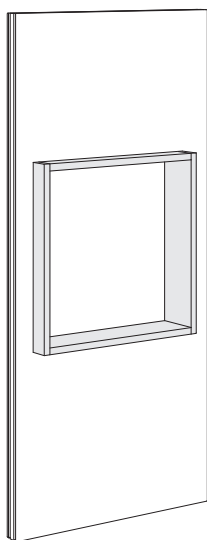

Window, open
Depth: 210 mm

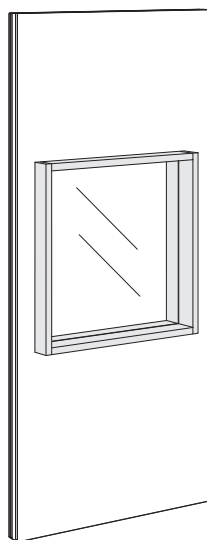

Window, glass
Depth: 100 mm on each side of the glass

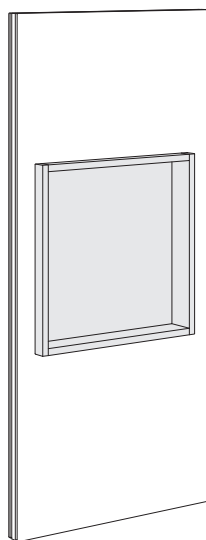

Lighting niche
Depth: 130 mm

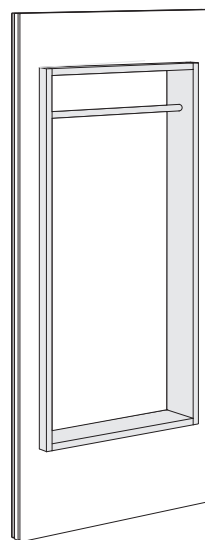

Window, open with clothes rail
Depth: 210 mm
Diameter: 30 mm

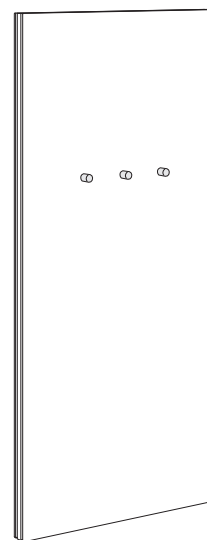

Coat hooks
Height: 1500 mm

LimbusBuildup

Partitions

Design: Johan Kauppi

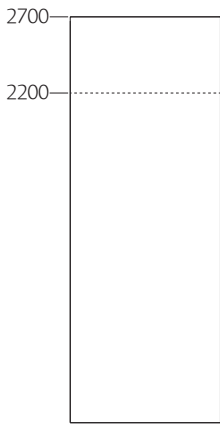

Straight
2.7 m 57050527010
2.2 m 57050522010

Screen
1000 mm

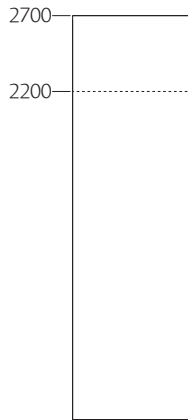

**Straight,
custom made**
2.7 m on request
2.2 m on request

Screen
<1000 mm

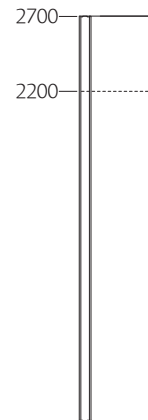

Curved
2.7 m 57050527100
2.2 m 57050522100

Screen
r500 mm

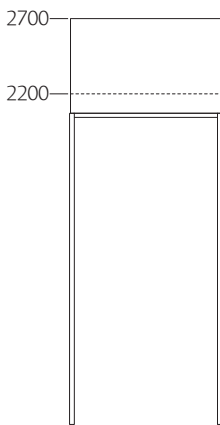

2.7 m 57102027052
2.2 m 57102022052

Frame
1000 x 2100 mm

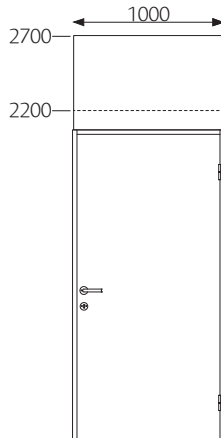

**Right-hinged
Birch**
2.7 m 57102027051
2.2 m 57102022051

Door
825 x 2040 mm

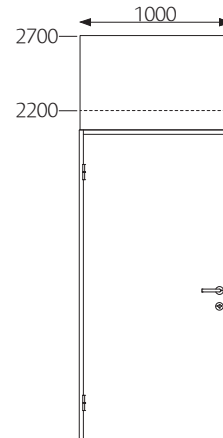
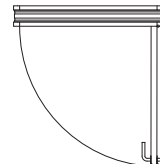

**Left-hinged
Birch**
2.7 m 57102027050
2.2 m 57102022050

Door
825 x 2040 mm

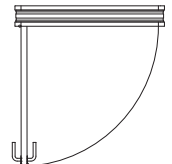

90°
2.7 m 57050527121
2.2 m 57050522121

Connecting pole
80 x 80 mm



3-way
2.7 m 57050527123
2.2 m 57050522123

Connecting pole
80 x 80 mm

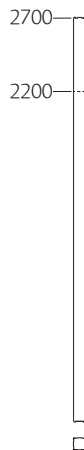

4-way
2.7 m 57050527124
2.2 m 57050522124

Connecting pole
80 x 80 mm



End
2.7 m 57050527122
2.2 m 57050522122

End / Wall strip
80 x 30 mm

LimbusBuildup

Partitions

Design: Johan Kauppi

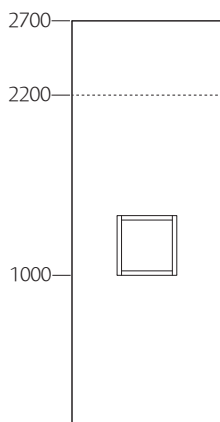

Clear glass
2.7 m 57040427021
2.2 m 57040422021

Frosted glass
2.7 m 57040427031
2.2 m 57040422031

Open
2.7 m 57040427001
2.2 m 57040422001

Lighting niche
2.7 m 57040427041
2.2 m 57040422041

Window
400 x 400 mm

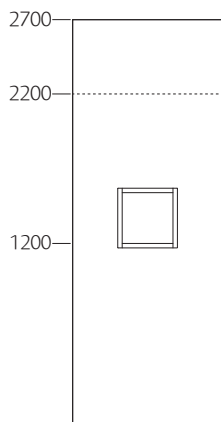

Clear glass
2.7 m 57040427022
2.2 m 57040422022

Frosted glass
2.7 m 57040427032
2.2 m 57040422032

Open
2.7 m 57040427002
2.2 m 57040422002

Lighting niche
2.7 m 57040427042
2.2 m 57040422042

Window
400 x 400 mm

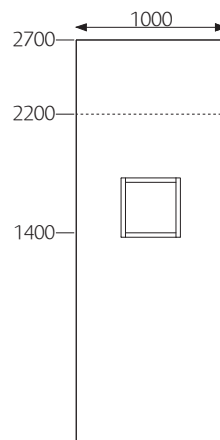

Clear glass
2.7 m 57040427023
2.2 m 57040422023

Frosted glass
2.7 m 57040427033
2.2 m 57040422033

Open
2.7 m 57040427003
2.2 m 57040422003

Lighting niche
2.7 m 57040427043
2.2 m 57040422043

Window
400 x 400 mm

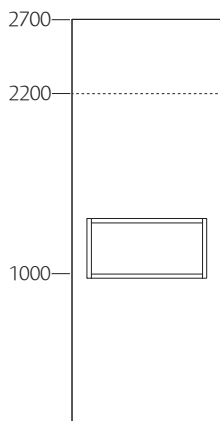

Clear glass
2.7 m 57080427021
2.2 m 57080422021

Frosted glass
2.7 m 57080427031
2.2 m 57080422031

Open
2.7 m 57080427001
2.2 m 57080422001

Lighting niche
2.7 m 57080427041
2.2 m 57080422041

Window
800 x 400 mm

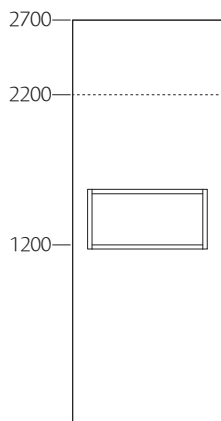

Clear glass
2.7 m 57080427022
2.2 m 57080422022

Frosted glass
2.7 m 57080427032
2.2 m 57080422032

Open
2.7 m 57080427002
2.2 m 57080422002

Lighting niche
2.7 m 57080427042
2.2 m 57080422042

Window
800 x 400 mm

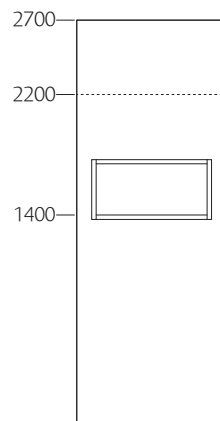

Clear glass
2.7 m 57080427023
2.2 m 57080422023

Frosted glass
2.7 m 57080427033
2.2 m 57080422033

Open
2.7 m 57080427003
2.2 m 57080422003

Lighting niche
2.7 m 57080427043
2.2 m 57080422043

Window
800 x 400 mm

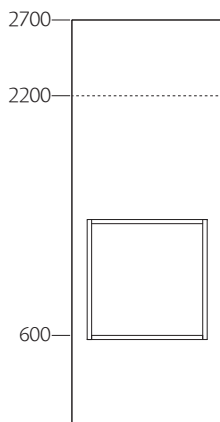

Clear glass
2.7 m 57080827021
2.2 m 57080822021

Frosted glass
2.7 m 57080827031
2.2 m 57080822031

Open
2.7 m 57080827001
2.2 m 57080822001

Lighting niche
2.7 m 57080827041
2.2 m 57080822041

Window
800 x 800 mm

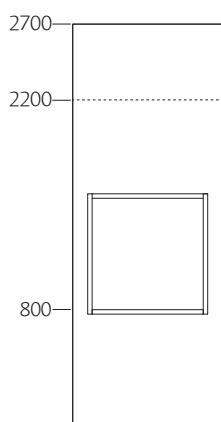

Clear glass
2.7 m 57080827022
2.2 m 57080822022

Frosted glass
2.7 m 57080827032
2.2 m 57080822032

Open
2.7 m 57080827002
2.2 m 57080822002

Lighting niche
2.7 m 57080827042
2.2 m 57080822042

Window
800 x 800 mm

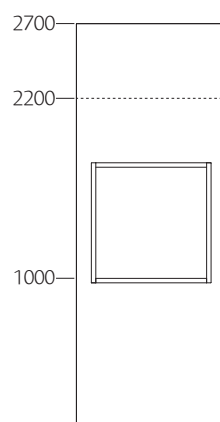

Clear glass
2.7 m 57080827023
2.2 m 57080822023

Frosted glass
2.7 m 57080827033
2.2 m 57080822033

Open
2.7 m 57080827003
2.2 m 57080822003

Lighting niche
2.7 m 57080827043
2.2 m 57080822043

Window
800 x 800 mm

LimbusBuildup

Partitions

Design: Johan Kauppi

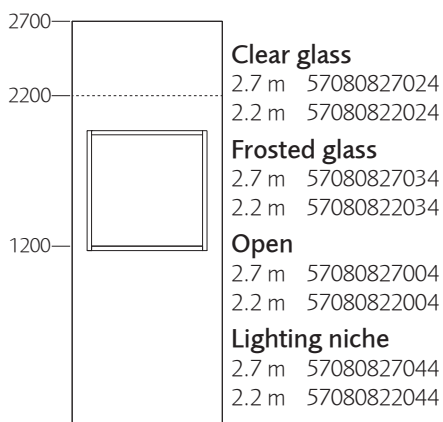

Window
800 x 800 mm

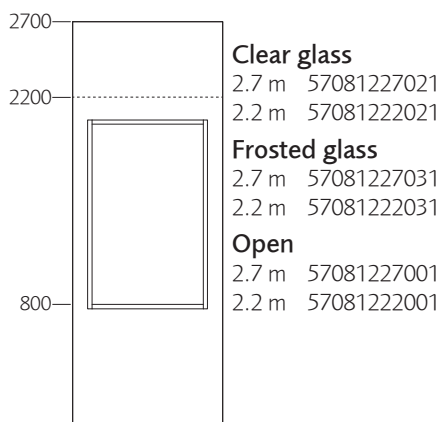

Window
800 x 1200 mm

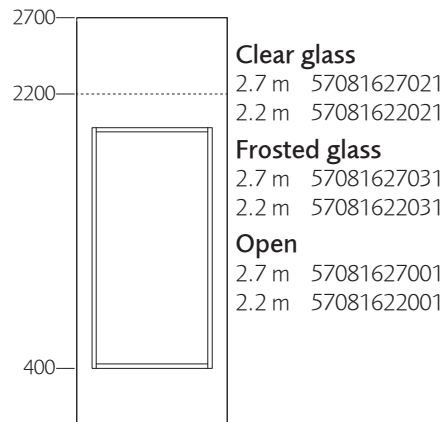

Window
800 x 1600 mm

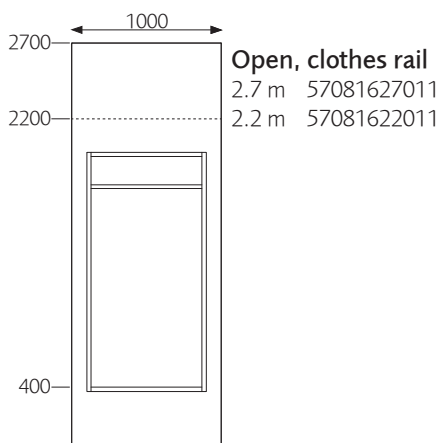

Window
800 x 1600 mm

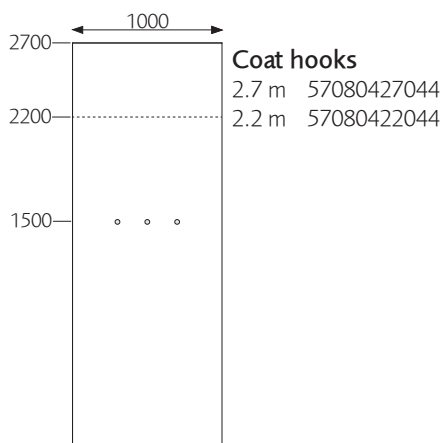

Coat hooks
Ø32 x 45 mm

LimbusBuildup

Partitions

Design: Johan Kauppi

DESCRIPTION

Curved and straight upholstered system walls with width of 1000 mm or radius 500 mm. Height 2200 mm alt. 2700 mm. Body: 35 mm sound absorbing polyether (Oeko-Tex) glued on both sides of an 8 mm sound reducing MDF board (Nordic Ecolabel) with a 80 mm solid wood frame.

Upholstery: Upholstered with fabric on both sides.

The screens can be equipped with door, windows and lighting niches with protruding frame in birch.

Window: Clear glass, frosted glass or open. Windows, open, can be fitted with clothes rail in birch.

Coat hooks: 3 pcs in birch, Ø32 x 45 mm

Lighting niche: Back in birch and integrated LED strip at the top. Upholstered backside. Drivers are placed on the top of the screen. 3 m power cable with European connector.

Door: Door 825x 2040 mm birch. Right or left.

Connection: Upholstered connection poles 90°, 3-way or 4-way. Ending: Upholstered end strip.

100% recyclable materials.

MOUNTING

The elements are delivered semi assembled. The walls are easily connected with pre mounted special fitting (pic 1).

Niches, frames and doors are installed on site. The assembly requires no extra ceiling height and requires two persons.

Stability is achieved with wall connectors, angled screens and ceiling wire for mounting. Glimakra will assist with advice regarding stability, performance and acoustics. Mounting with ceiling wire (pic 2).



1. Special fitting

FABRIC AND PIPING

Look in Product sheet Fabric and piping.pdf for our standard fabrics, you can download it here: <http://glimakra.com/en/download/>.

OPTIONS

Electricity: Simple white power socket recessed in a junction box 200 mm above floor.

CERTIFICATE

Glimakra of Sweden AB is certified according to ISO 9001:2015 and ISO 14001:2015.



SPECIFICATION TEXT

Eg. Glimakra LimbusBuildup room 3160 x 3160 x 2200 mm consisting of:

7 pcs LimbusBuildup 1000 x 2200 mm, fabric: Blazer CUZ28

1 pc LimbusBuildup 1000 x 2200 mm, fabric: Blazer CUZ28, with window 800 x 800 mm, height 600 mm, clear glass.

1 pc LimbusBuildup 1000 x 2200 mm, fabric: Blazer CUZ28, with window 800 x 800 mm, height 800 mm, clear glass.

Power socket white.

1 pc LimbusBuildup 1000 x 2200 mm, fabric: Blazer CUZ28, with window 800 x 800 mm, height 1000 mm, clear glass.

Power socket white.

1 pc LimbusBuildup 1000 x 2200 mm, fabric: Blazer CUZ28, with lighting niche 800 x 800 mm, height 1000 mm.

1 pc LimbusBuildup 1000 x 2200 mm, fabric: Blazer CUZ28, with door 825 x 2040 mm, left.

4 pcs LimbusBuildup upholstered connection poles 90°, fabric: Blazer CUZ28.

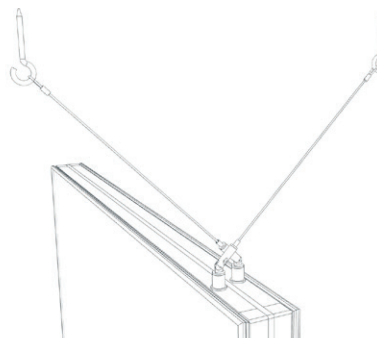

2. Ceiling wire

LimbusBuildup

Partitions

Design: Johan Kauppi

