

PRODUCT SHEET / 2018 04 06

LimbusFloor Subtle

Floor screen

Design: Team Glimakra / Johan Kauppi

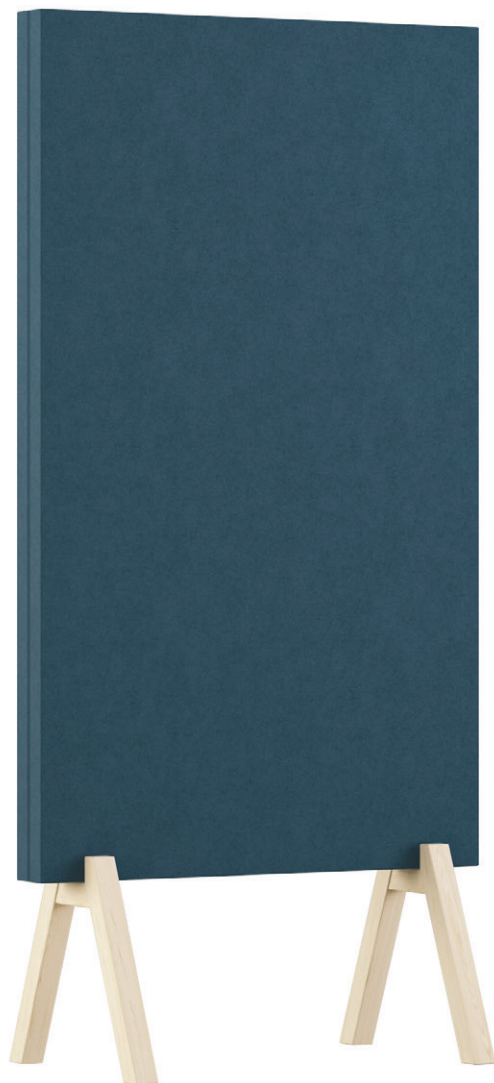

LimbusFloor Subtle

Floor screen

Design: Team Glimakra / Johan Kauppi

LimbusFloor Subtle is a family of floor screens with a modern, light expression. The screens are robust with extra good sound absorption. The legs in solid wood are inspired by traditional trestles and gives the floor screens a free and creative expression. LimbusFloor Subtle is suited to be furnished in dynamic groups as well as repeated in rows.

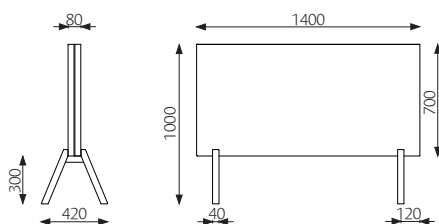

1400 x 1000 mm

Weight / Volume: 9,5 kg / 0,11 m³

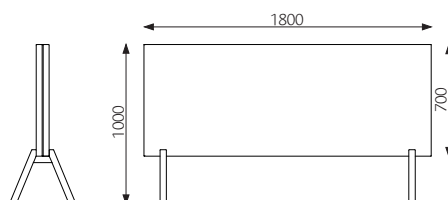

1800 x 1000 mm

Weight / Volume: 12,9 kg / 0,14 m³

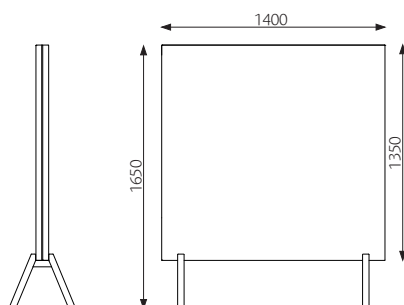

1400 x 1650 mm

Weight / Volume: 17,2 kg / 0,20 m³

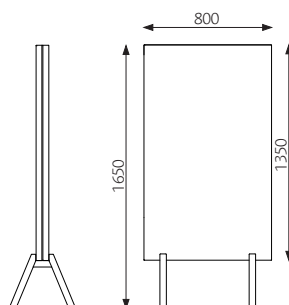

800 x 1650 mm

Weight / Volume: 11,3 kg / 0,12 m³

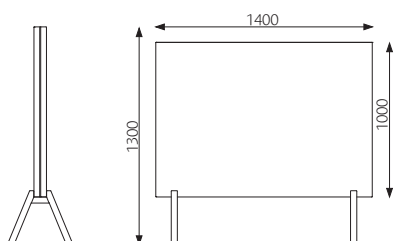

1400 x 1300 mm

Weight / Volume: 13 kg / 0,15 m³

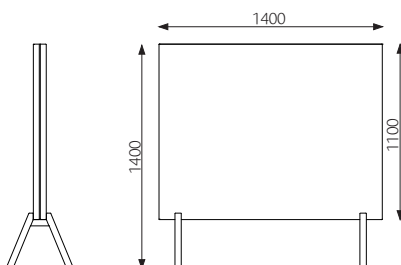

1400 x 1400 mm

Weight / Volume: 14,4 kg / 0,16 m³

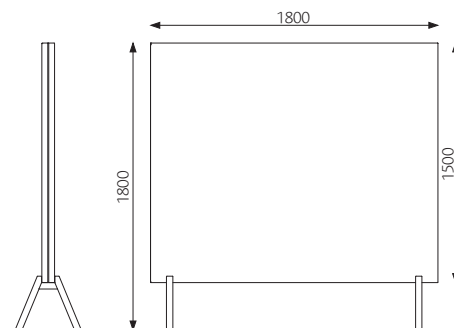

1800 x 1800 mm

Weight / Volume: 18,9 kg / 0,28 m³

LimbusFloor Subtle

Floor screen

Design: Team Glimakra / Johan Kauppi



DESCRIPTION

Body: A wooden frame 80 x 30 mm, joined together with sharp corners and filled with an 80 mm solid sound absorbing polyether (Oeko-Tex).

Upholstery: Upholstered with fabric on both sides. The nails are hidden by a decorative piping.

Foot: 420 x 300 x 40 mm in white stained ash. The foot adds about 300 mm.

Installation: The feet are screwed into the bottom of the wooden frame (M6).

100% recyclable materials.

FABRIC AND PIPING

Look in Product sheet Fabric and piping.pdf for our standard fabrics, you can download it here: <http://glimakra.com/en/download/>

CERTIFICATE

Acoustics: Measurements made in accordance with ISO 354:2003. Evaluation made according to standards for individual objects SS 25269:2013 (Report 14-186-M1, Date 2014-12-10, Akustikverkstan, laboratory accredited by Swedac)

Möbelfakta: The product has been declared and approved in accordance with the criteria for floor screens in Möbelfakta ver. 2015-05-01. Reg. No: 0220151216. Valid until 2020-12-16.



Glimakra of Sweden AB is certified according to ISO 9001:2015 and ISO 14001:2015.



SPECIFICATION TEXT

E.g: LimbusFloor Subtle floor screen 1400 x 1400 x 80 mm with feet in white stained ash.

80 mm sound absorbing filling. Sharp corners.

Fabric: Blazer CUZ 28. No visible seams. Nails hidden by piping black 190.

Acoustics evaluated according to SS 25269.

LimbusFloor Subtle

Floor screen

Design: Team Glimakra / Johan Kauppi

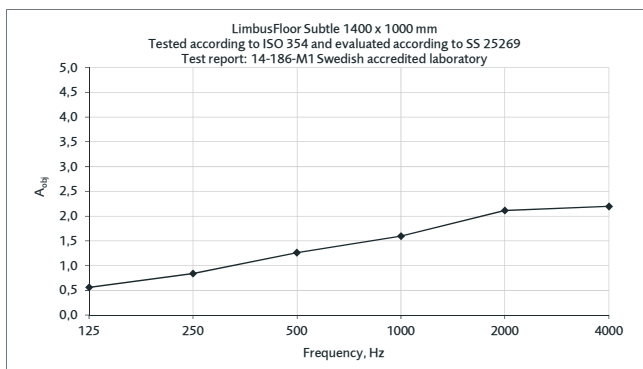

Equivalent absorption area per object (m²S/object)

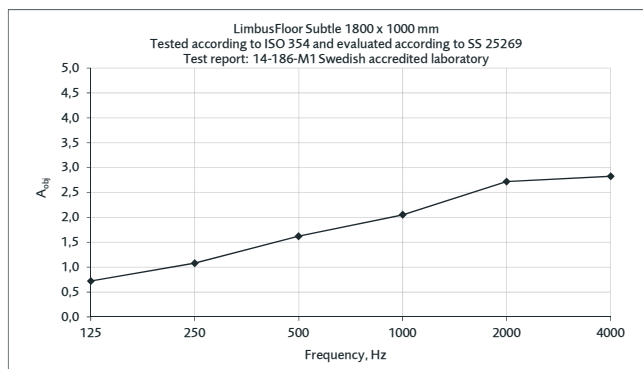

Equivalent absorption area per object (m²S/object)

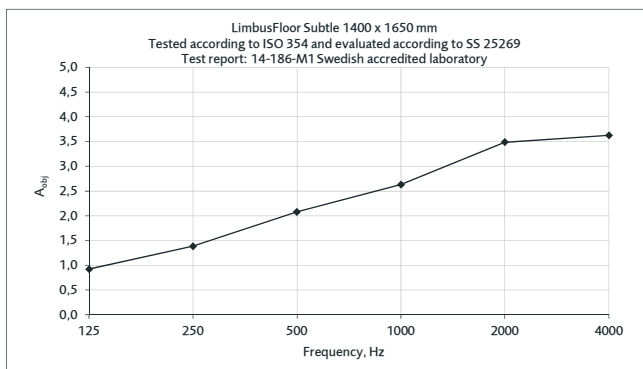

Equivalent absorption area per object (m²S/object)

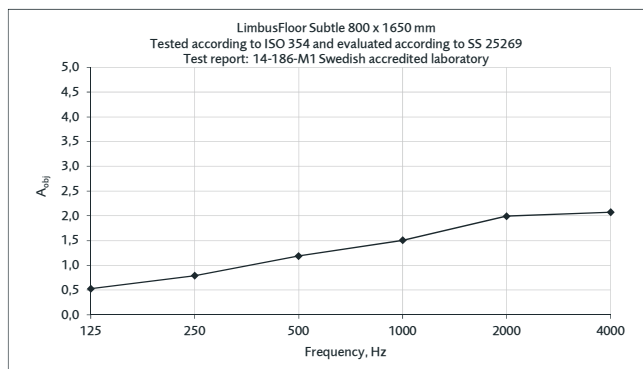

Equivalent absorption area per object (m²S/object)

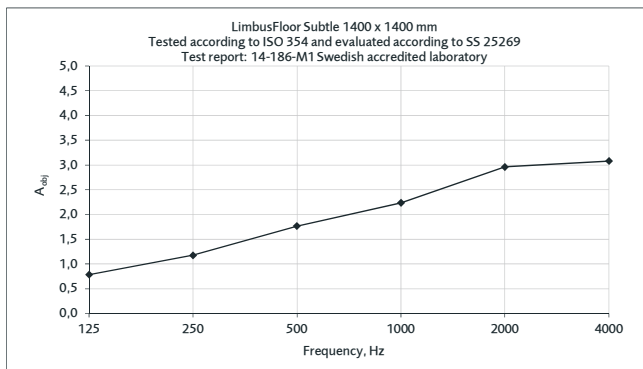

Equivalent absorption area per object (m²S/object)

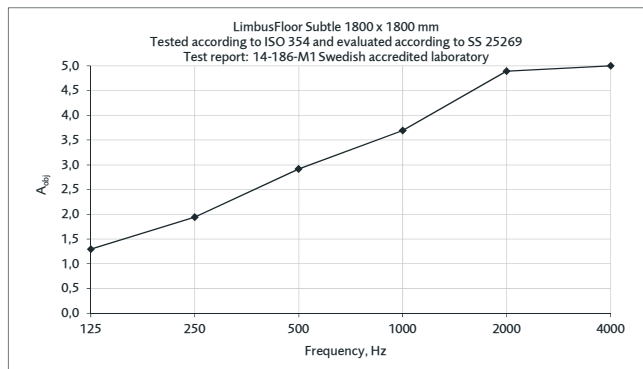

Equivalent absorption area per object (m²S/object)

PRODUCT SHEET / 2018 04 06

LimbusFloor Subtle

Floor screen

Design: Team Glimakra / Johan Kauppi

