

# BuildUp Pods R1 & R2

Design: Kauppi & Kauppi



---

Vi rekommenderar att du följer våra monteringsanvisningar för att säkerställa att din möbel från Glimakra of Sweden varar i många år. / We recommend to follow our assembly instructions to ensure that your Glimakra of Sweden furniture lasts for many years.

---



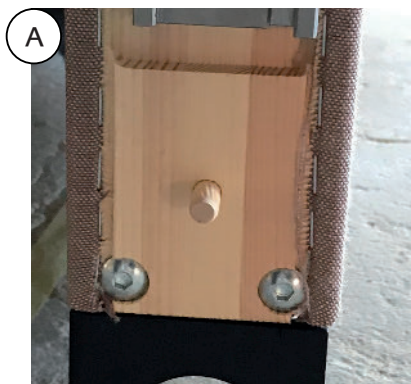

SE

A. Sätt i 3 centrumtappar i ramen på ena sidan för att styra skärmen rätt vid montering.

EN

A. Insert 3 wooden center pins in the frame on one side to guide the screen correctly when mounting.



3 st./pcs

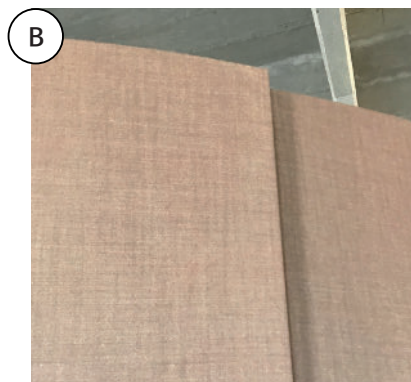

SE

B. Börja att montera ihop skärm 1 och 2 enligt ritning.

EN

B. Start assembling screens 1 and 2 according to the drawing.

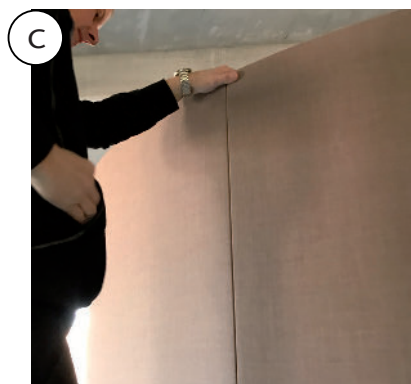

SE

C. Skärmarna förs ihop så att centrumtapparna styr in beslagen i rätt läge.

EN

C. The screens are brought together so that the center pins guide the fittings in the correct position.

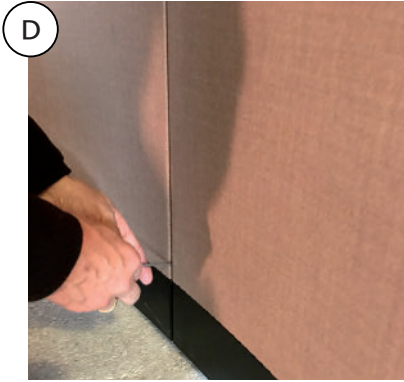

SE

D. Beslagen fixeras med medföljande insett-verktyg från båda sidor.

EN

D. The fittings are fixed with the included allen keys from both sides.

Insett-verktyg  
Allen keys/



SE

E. Fortsätt att montera ihop skärmarna i nummerordning.

EN

E. Continue assembling the screens in numerical order.



SE

F. Avslutningsvis monteras öppnings-skärmen mellan sista skärmen och skärm nr 1.

EN

F. Finally, the opening screen is mounted between the last screen and screen no. 1.

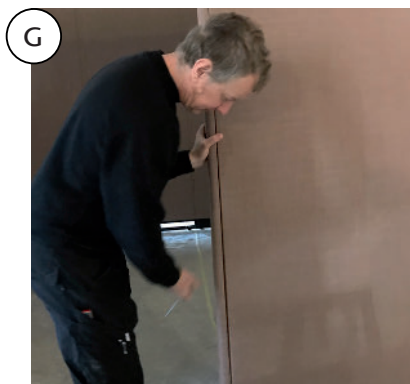

G

SE

G. Därefter monteras öppningslisterna

EN

G. Then the opening strips are mounted



H

SE

H. Takbalkarna har färdigmonterade fästbeslag för att underlätta montering.

EN

H. The roof beams have pre-assembled mounting brackets to facilitate installation.

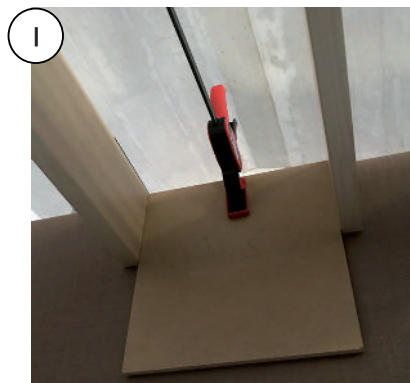

I

SE

I. Lägg upp de två mittersta takbalkarna med c/c 330mm. (använd mallskiva)

EN

I. Lay up the two middle roof beams with c / c 330mm. (use template)

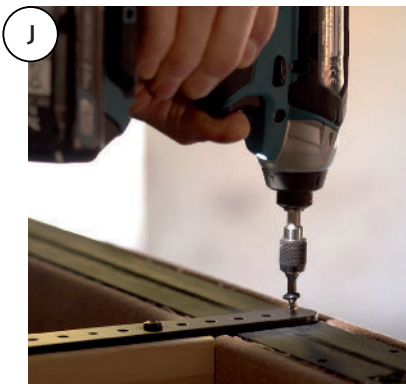

SE

J. Skruva fast balkarna med 2 skruv uppifrån.

EN

J. The beams are assembled with 2 screws from above.

---

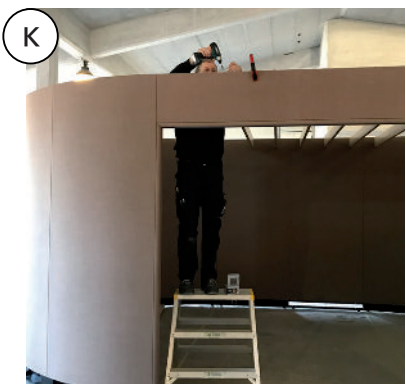

SE

K. Fortsätt att montera följande balkar med c/c 330mm.

EN

K. Continue to mount the following beams with c / c 330mm.

---

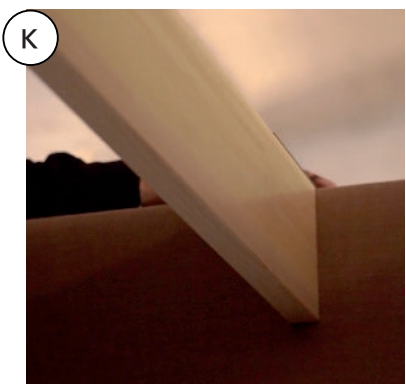

SE

K. Kontrollera efterhand att balkarna ligger emot skärmarna innan slutlig infästning görs.

EN

K. Make sure that the beams are tight against the screens before final attachment is made.

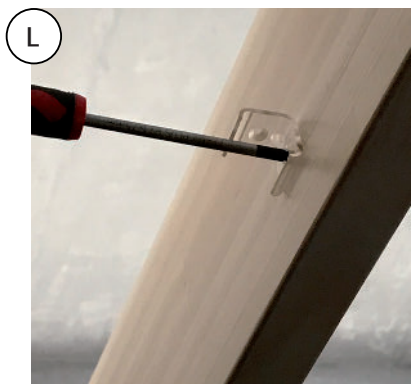

SE

L. Skruva fast LED-belysningar i takregel 2.

EN

L. Screw LED lights to roof beam 2.

---

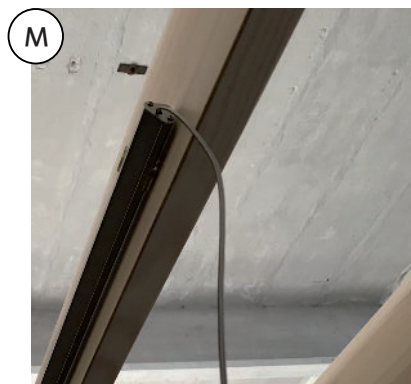

SE

M. Lågspänningskabel dras ovanpå takreglar till strömbrytarskärmens sockel och kopplas till gemensamt drivdon.

EN

M. Low-voltage cables are routed on top of roof beams to the socket of the switch screen and connected to same driver.

---

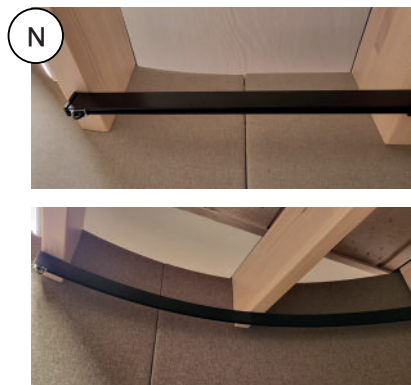

SE

N. Skruva fast gardinskenan med tillbehör i takbalkarna 60 mm från väggen.

EN

N. Screw the curtain rail to the roof beams 60 mm from the wall.

O



SE

O. Gardiner hängs upp i öglor i gardinskenan.

EN

O. Curtains are hung in loops in the curtain rail.

---

P

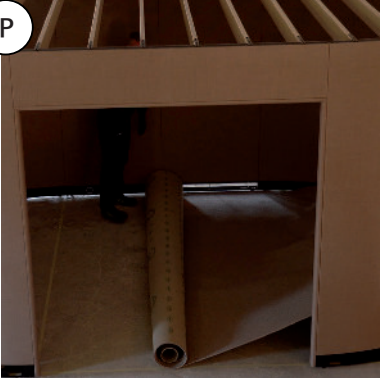

SE

P. Motrulla den formskurva mattan och lägg ut den i rummet. Mattan ska ligga 10mm in under skärmen.

EN

P. Roll up the carpet and lay it out in the room. The carpet should be 10mm under the screen.

---

Q



SE

Q. Fäst förklistrad akustiklist under sockeln runt om hela rummet.

EN

Q. Attach the preglued acoustic strip under the plinth around the entire room.



R

SE

R. Behörig elektriker kopplar in el till strömbrytarskärmens kopplingsdosa i sockeln. (elkabel ingår ej).

EN

R. A qualified electrician connects electricity to the junction box in the socket. (power cable not included).

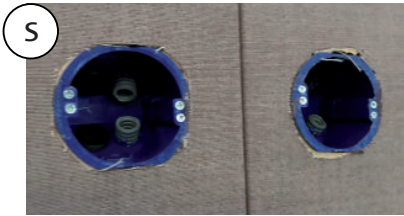

S

SE

S. El dras via kopplingsdosor i sockeln.

EN

S. Electricity is drawn via junction boxes in the base.

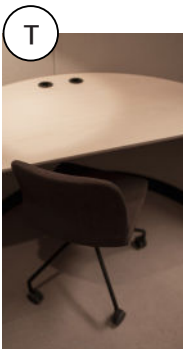

T

SE

T. Montera bordsskivan 740mm över golv.

EN

T. Install the table top 740mm above floor.

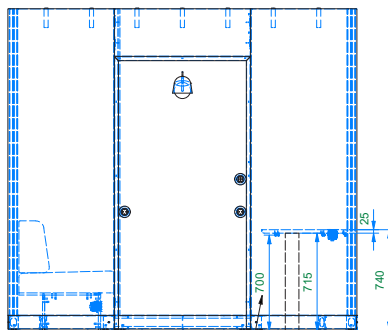

Skruvhöjd från golv

3st stödbitar under fastskruvning av bordsskiva



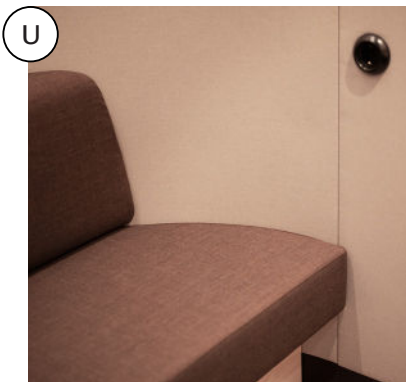

SE

U. Soffan sitter lös och behöver därmed inte monteras mot vägg.

EN

U. The sofa sits loose and does not need to be installed against the wall.

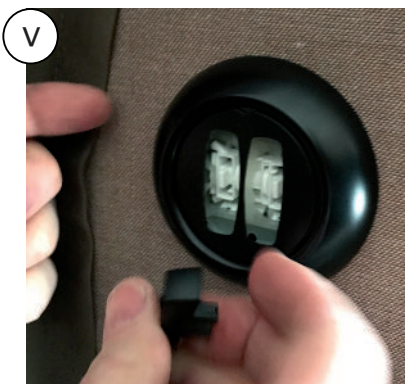

SE

V. LED-belysningar och vägglampan (r2) kopplas till vippströmbrytare av behörig elektriker.

EN

V. LED lighting and wall lamp (r2) are connected to switches by a qualified electrician.

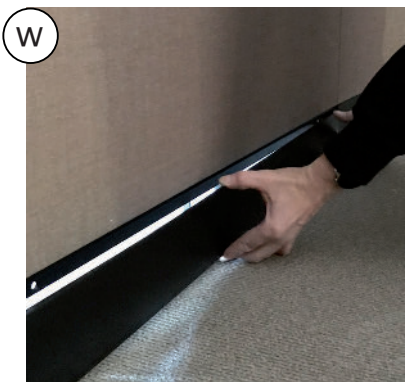

SE

W. Montera luckor på socklarna på samtliga skärmar.

EN

W. Mount covers on the sockets on all screens.

## BuildUp Pods R1 & R2

### SE ANSLUTNING AV EL BUILDUP PODDEN

Kunden behöver anlita en behörig elektriker. Detta för att varje lands elsäkerhetskrav ska vara med i åtanken.

Strömbrytare och svenska vägguttag som levereras är CE-märkta. Elektrikern ska kontrollera om dessa får användas. Elkabel ingår ej i leveransen.

Ansluten el dras till kopplingsdosan i sockeln under Switchen. Antingen direkt via hål under sockeln eller uppifrån genom Flexrör i skärm till sockel.

Från kopplingsdosan dras strömmen till Switchen, vägguttag, vägglampa och drivrutinen till LED-belysningen som också är placerad i sockeln.

### EN CONNECTING ELECTRICITY IN THE BUILDUP POD

The customer must hire a qualified electrician. This is so that each country's specific electrical safety requirements are taken into account.

Switches and Swedish wall sockets as delivered are CE marked. Electricians must verify if these may be used. Electric cable is not included in the delivery.

Incoming electricity is drawn to the junction box in the plinth below the Switch. Either directly via holes under the plinth or from above through Flex tubes in the screen to the plinth.

From the junction box, electricity is drawn to the Switch, wall socket, wall lamp and the driver of the LED lighting, which is also placed in the plinth.



1.



2.



3.



4.



5.



6.



7.



8.



## SE DU BEHÖVER:

1. Kopplingsdosa Click IP55
2. Rotdosa för 16 mm flexrör
3. Schneider Electric, Renova Switch 16A 230V
4. Väggtuttag 1-vägsuttag jordad
5. LED-belysning och beslag
6. Spikklemmer TC för rund ledning
7. LED-Driver. HEP- 60W 24V
8. Flexrör

## EN YOU NEED:

1. Junction box Click IP55
2. Switch box junction box for 16 mm tubes
3. Schneider Electric, Renova Switch 16A 230V
4. Wall socket, earth
5. LED-Lighting and fittings
6. Nail staples
7. LED-Driver. HEP- 60W 24V
8. Flex pipe, inside screen

## SE STRECK, VÄGGLAMPA FRÅN ÖRSJÖ INDUSTRI AB

- Class I IP20 230V.
- 1 x 6W LEDmodule 2700K 660lm CRI90
- Monteras med träskruv i skärm. Kopplas till vippströmbrytare.



## EN STRECK, WALL LAMP FROM ÖRSJÖ INDUSTRI AB

- Class I IP20 230V
- Switch inside shade. Adjustable shade. Housing.
- 1x 6W LEDmodule 2700K 660lm CRI90
- Mounted with wood screws in screen. Connects to switches.

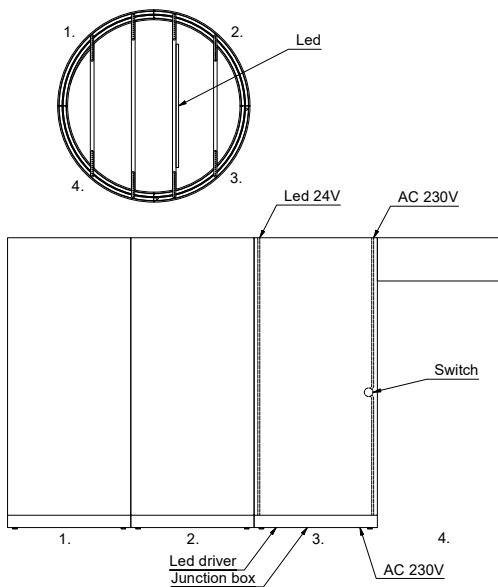

## BuildUp Pod R1

SE Eldragning instruktioner

EN Electrical wiring instructions

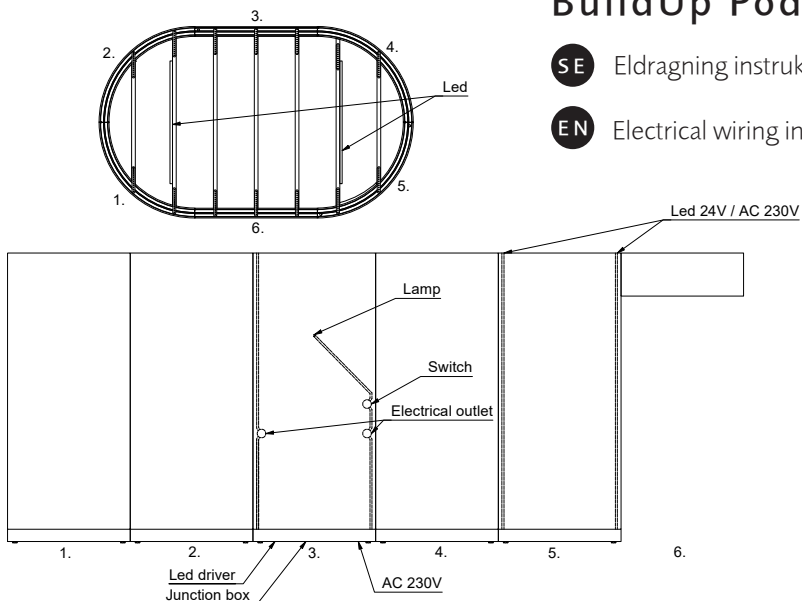

## BuildUp Pod R2

SE Eldragning instruktioner

EN Electrical wiring instructions