

Fences

Acoustic floor screens

Design: Johan Kauppi



GLIMAKRA
OF SWEDEN

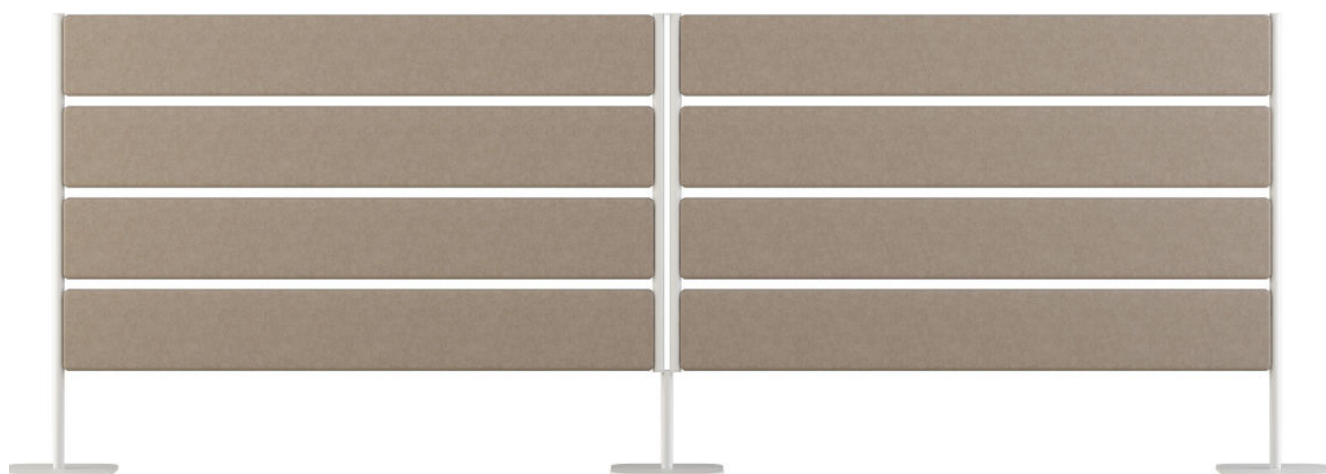

Fences

Acoustic floor screens

Design: Johan Kauppi

A family of repeatable room dividers, for meetings and work. The design has a clear horizontal expression, inspired by the landscape of Swedish Lapland. The system is based on identical acoustic baffles of fabric, mounted at consistent distances, giving the furniture a balanced combination of sound absorption and transparency, for large-scale repetition in public interiors.

DIMENSIONS

Fences 4

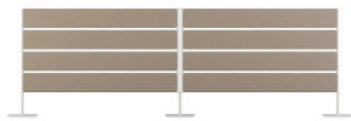

Width: 1200, 1600 mm
Height: 1103 mm
Weight: 38 kg, 42 kg
Thickness: 33 mm (panels),
30 mm (pipes)

Fences 6

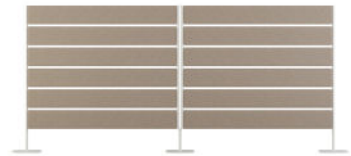

Width: 1200, 1600 mm
Height: 1550 mm
Weight: 46 kg, 54 kg
Thickness: 33 mm (panels),
30 mm (pipes)

DESCRIPTION

Fences has 4 or 6 sound absorbing panels that hooks up with air gap between 30 mm white powder coated pipes. Between the screens, there are connecting pipes and the outer edges have endpipes. Each pipe is mounted on a 300 mm rectangular metal plate.

Panels: 19 mm lightweight MDF coated with 6 mm polyether and fabric. Piping in matching color.

Metal frame: Powder-coated NCS S 0500-N White
100% recyclable materials.

FABRIC AND PIPING

Look in Product sheet Fabric and piping.pdf for our standard fabrics, you can download it here:

<http://glimakra.com/en/download/>

MOUNTING

Fences: The panels with integrated brackets hatch quickly in the endpipe and coupling pipes with integrated coupling brackets. Then the feet are mounted and the screens can be raised to complete the assembly with the top and bottom coupling tabs.

OPTIONS

All Fence modules are also available with one solid baffle s.c. Fences Solid.





Fences

Acoustic floor screens

Design: Johan Kauppi

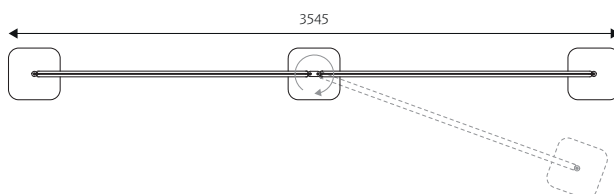
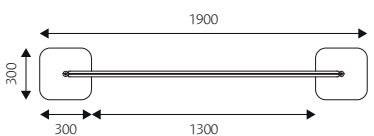
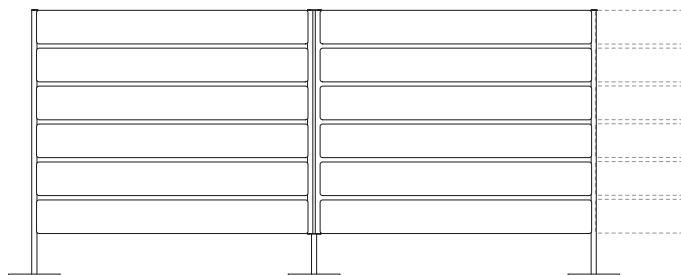
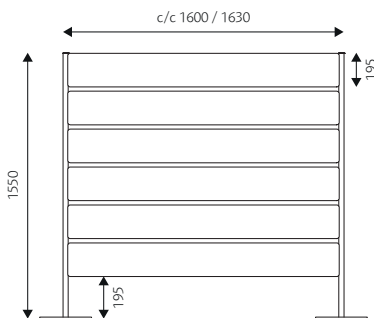
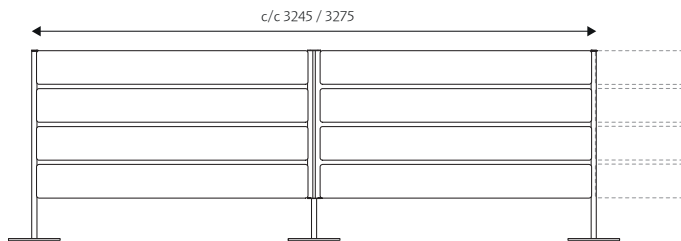
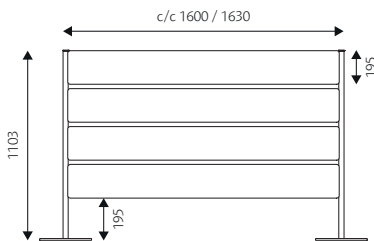
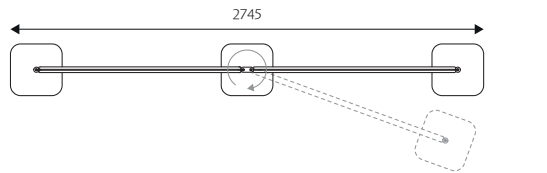
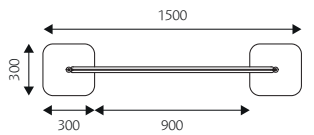
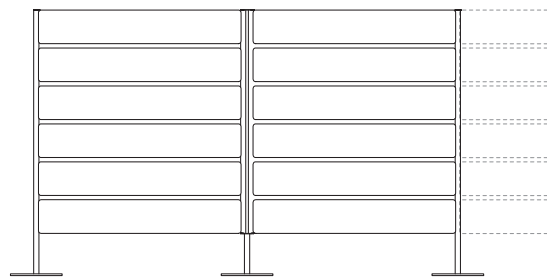
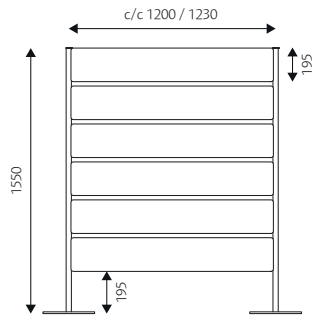
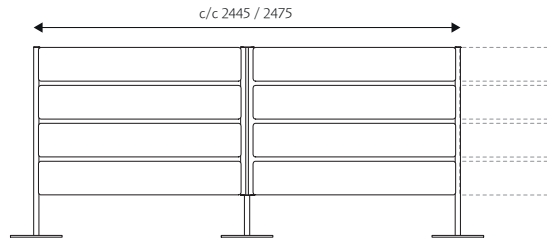
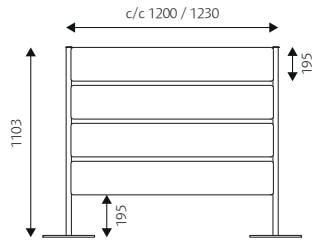

Fences

Acoustic floor screens

Design: Johan Kauppi

CERTIFICATES

Acoustics: Measurements made in accordance with ISO 354. Evaluation made according to standards for individual objects SS 25269 (Report 19-709-R1, Date 2019-04-08, Akustikverkstan, laboratory accredited by Swedac)

Glimakra of Sweden AB is certified according to ISO 9001:2015 and ISO 14001:2015.



SPECIFICATION TEXT

E.g: Fences 4, 1200x1103 mm, powder coated white. Fabric: Blazer CUZ28, piping18.

Sound absorption area according to ISO 354 and SS 25269

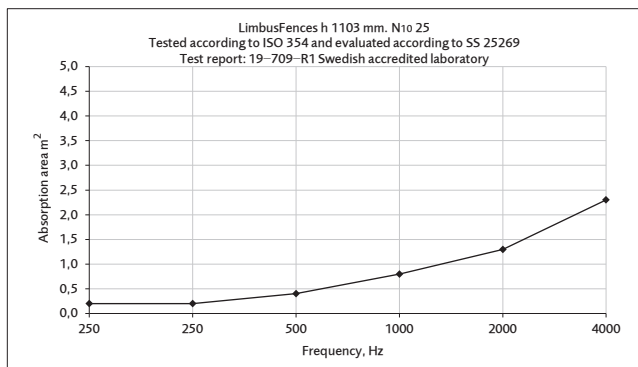

Sound absorption area according to ISO 354 and SS 25269

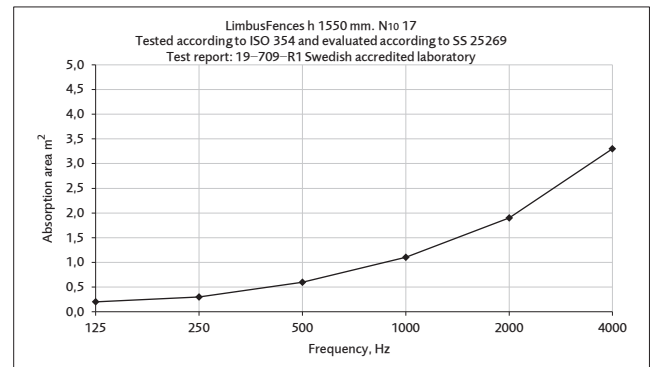

Fences

Acoustic floor screens

Design: Johan Kauppi



GLIMAKRA
OF SWEDEN

