

PRODUCT SHEET / 2024 03 20

# Limbus accessories

For desk up screens

Design: Team Glimakra



GLIMAKRA  
OF SWEDEN



# Limbus accessories - Addon

Addon screen for desk up screens

Design: Team Glimakra

With Limbus Addon, you can reduce sound propagation while retaining a free field of view and maintaining a good light inlet. Limbus Addon can be customized to most desk-up screens and floor screens in the range of Contrast and Limbus by Glimakra.

## DIMENSIONS

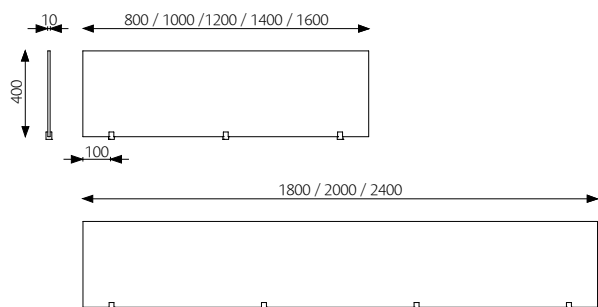

Other dimensions on request.

**Thickness:** 10 mm

**Corner radius:** Lower corner 6 mm, upper corner 15 mm  
(Exception to LimbusDeskup Soft and LimbusFloor Soft where all corners have a radius of 15 mm.)

### Weight [kg]:

Height [mm]:	400
Width 800 mm	3.7
Width 1000 mm	4.6
Width 1200 mm	5.5
Width 1400 mm	6.4
Width 1600 mm	7.4
Width 1800 mm	8.3
Width 2000 mm	9.2
Width 2400 mm	11.0

## DESCRIPTION

Custom fitted addon screen for mounting on a adapted desk-up screen or floor screen.

Suitable for desk-up screens and floor screens in the range of Contrast and Limbus by Glimakra. Other uses on request.

**Material:** Acrylic plastic

**Fitting:** Aluminium, adds 10 mm

**Mounting:** Attached to the screen with 3-4 fittings in integrated threaded sleeves.

100% recyclable materials.

Additional fittings for existing table screens are available.

## PLACING OF FITTINGS

### Screen width up to 1799 mm:

3 fittings, 2 are placed 100 mm from outer edge to hole center and 1 is placed in the middle.

### Screen width 1800-2400 mm:

4 fittings, 2 are placed 100 mm from outer edge to hole center and 2 are placed evenly distributed between the outer fittings.

## CERTIFICATES

Glimakra of Sweden AB is certified according to ISO 9001:2015 and ISO 14001:2015.



## SPECIFICATION TEXT

E.g: Glimakra Limbus Addon 1600 x 400 x 10 mm.

Transparent addon screen mounted on a desk-up screen.

# Limbus accessories - Addon

Addon screen for desk up screens

Design: Team Glimakra



GLIMAKRA  
OF SWEDEN



# Limbus accessories - Glimma

Toolbars for desk up screens

Design: Team Glimakra



GLIMAKRA  
OF SWEDEN

A toolbar with a modern feel, but also flexible, stable and beautiful. The toolbar shows as little metal as possible, this is achieved with a fabric strip. Visually, the toolbar is perceived as two thin parallel lines that are linked to the rounded ends. As an alternative, it also comes with traditional straight finishes.

## TOOLBAR

Aluminium powder coated. Ending: ABS coated.

## DESCRIPTION

Colour: White RAL 9010

Size: 76 x 11 mm, fabric strip 25 mm

Double grooves 8 mm. c/c 54 mm

### Integrated rounded end / External rounded end

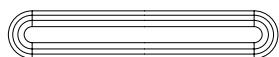

920 / 1120 / 1320 / 1520 / 1720 / 1920 / 2320

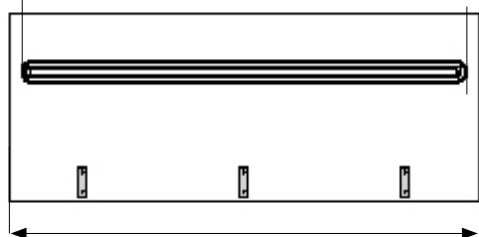

1000 / 1200 / 1400 / 1600 / 1800 / 2000 / 2400

### External straight end



852 / 1052 / 1252 / 1452 / 1652 / 1852 / 2252

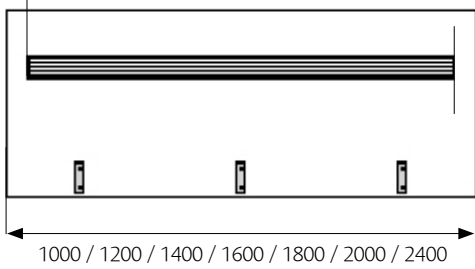

1000 / 1200 / 1400 / 1600 / 1800 / 2000 / 2400

For Limbus Soft and Limbus Light, the toolbar is screwed directly into the screen. The toolbar is assembled in the factory. Integrated toolbar with straight ends are not available. Most accessories on the market fit in the toolbar. However, external accessories should be tested / approved before ordering.

## FABRIC

Fabric consumption: screen length / 15. Fabric is included in the toolbar price. The fabric in the fabric strip is the same as on the screen, other fabric in the fabric strip on request.

## CERTIFICATES

Glimakra of Sweden AB is certified according to ISO 9001:2015 and ISO 14001:2015.



The screens are tested to handle 15kg according to Möbelfaktas requirements.

## SPECIFICATION TEXT

Glimma toolbar 1520 mm with rounded ending, CUZ28 grey, integrated white.

## OTHER INFORMATION

For heavier loads, an extra screen support is recommended, see illustration below.

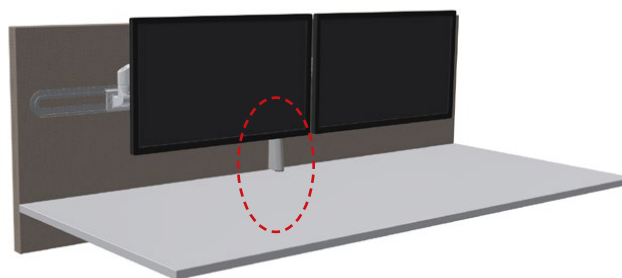

Normal load

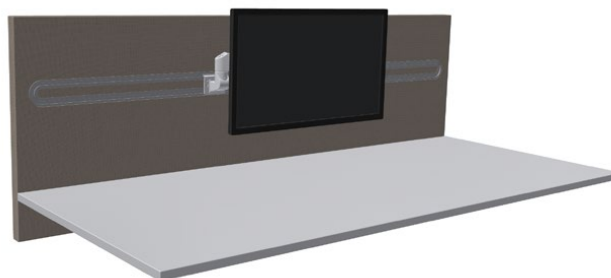

# Limbus accessories - Glimma

Acrylic accessories

Design: Team Glimakra



GLIMAKRA  
OF SWEDEN

## ACCESSORIES

Material: 3 mm clear acrylic

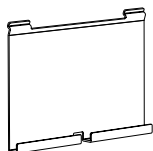

**Tablet Holder**  
336 x 243 x 20 mm

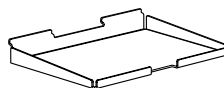

**A4 Shelf**  
330 x 235 x 30 mm

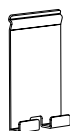

**Mobile holder**  
105 x 188 x 20 mm

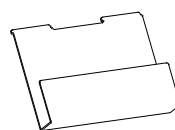

**Laptop Shelf**  
330 x 242 x 50 mm

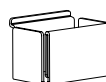

**Business Card holder**  
105 x 71 x 50 mm

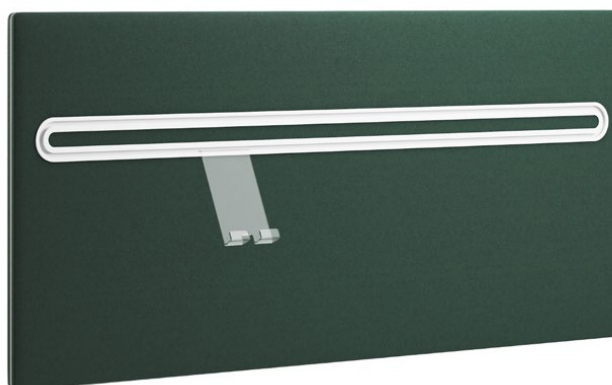

# Limbus accessories - Lykke

Lighting for desk up screens

Design: Forming Function



GLIMAKRA  
OF SWEDEN

Lykke was born from the idea of creating beautiful and innovative lighting for modern workplaces. A desk lamp that fulfils the same function as ceiling luminaires and traditional table luminaires, but in a new way. Lykke spreads the light evenly over the entire work surface, freeing up table space and is also easy to adjust.

## DIMENSIONS

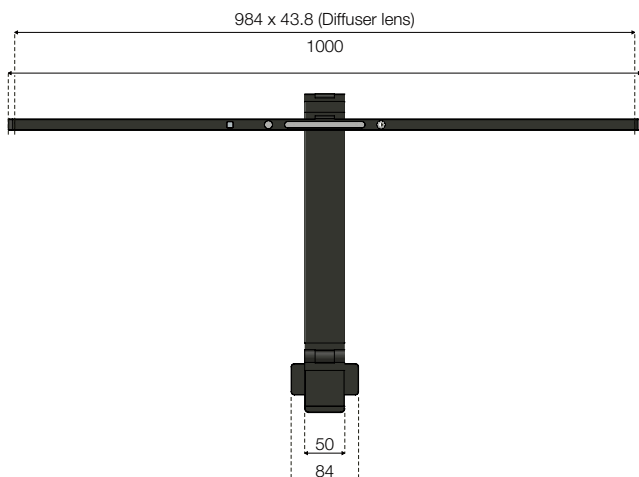
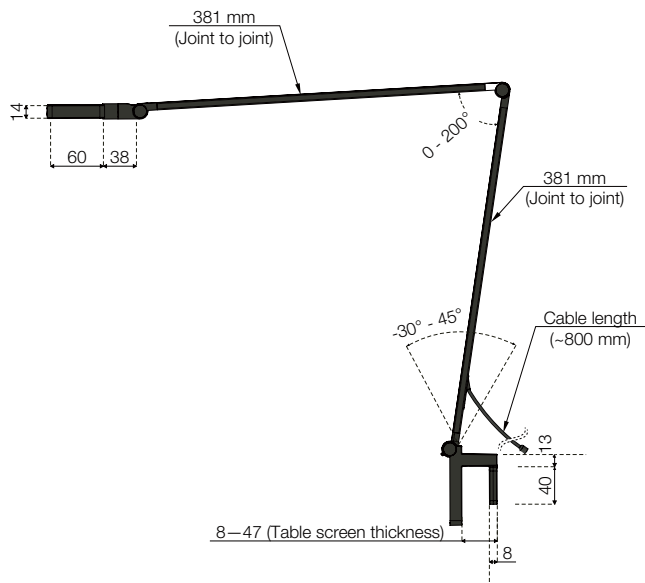

## DESCRIPTION

Lykke is integrated in your workspace and always gives you exactly the light you're after. The armature is attached to the desk screen and sits on a fixture that can be tilted to desired height. Different days calls for different light intensities. Therefore, Lykke has a touch panel that allows you to adjust the light temperature and brightness according to any need or occasion. With the help of a PIR sensor, the lamp also switches off when the work surface has been empty for 15 minutes. Lykke comes in the colours white and black.

## SPECIFICATIONS

- Flicker-free
- 2000 — 200 Lux (from lightsource)
- 2450 Lumen (6500 K, from lightsource)
- 100 Lm/W (6500 K, from lightsource)
- 3000 / 4000 / 6000 Kelvin
- UGR: <17
- CRI: 94 Ra
- PIR
- 220-240V, DC 24V 1.5A (24W), Max 36W

## CABLES

- 1 x 0.8 m integrated DC cable
- 1 x 1.8 m DC adapter (Europlug)

PRODUCT SHEET / 2024 03 20

# Limbus accessories - Lykke

Lighting for desk up screens

Design: Forming Function



GLIMAKRA  
OF SWEDEN

