

# Limbus Hexagon

Work booth

Design: Team Glimakra



GLIMAKRA  
OF SWEDEN



# Limbus Hexagon

Work booth

Design: Team Glimakra

Limbus Hexagon uses a geometric shape commonly found in nature to create efficient focused workplaces. One of the advantages of Hexagon work booths is that you are surrounded by five screens, which creates a more private and cozy work environment than traditional work booths. Another advantage of Limbus Hexagon is that the more hexagons you add in a cluster, the more affordable it becomes per workplace because the workplaces share screens with each other in an extremely efficient way. Limbus Hexagon is assembled with Glimakra's unique connection system. Table tops are available in several different designs and are integrated in the Limbus Hexagon construction.

## DIMENSIONS

Hex 1

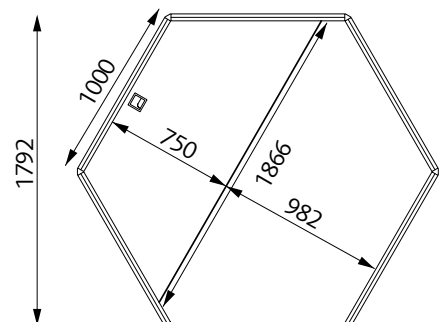
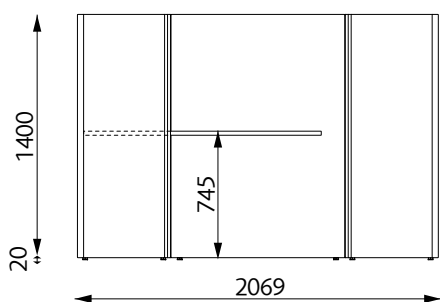

Other combinations on request.

Thickness: 40 mm

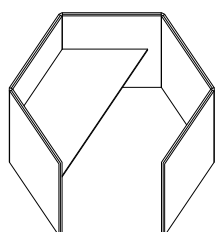

Width front:	1866 mm
Width back:	1000 mm
Depth:	750 mm
Height table top:	745 mm
Height over table:	650 mm

## DESCRIPTION

**Body:** 15 mm sound absorbing polyether (Oeko-Tex) glued on both sides of an 8 mm sound reducing MDF board with a 40 mm frame. Prepared with grey cable feedtrough Ø80 mm between workplaces.

**Upholstery:** Upholstered with fabric on both sides. The nails are covered with a decorative piping.

**Tabletop:** Veneer or laminate with cable feedtrough in aluminium. Located in the middle.

**Mounting:** Connected with connections poles. Connection pole in solid black-stained birch, 3-way and 2-way.

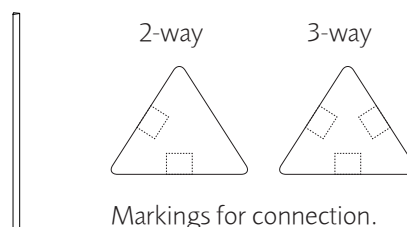

Delivered unassembled.

100% recyclable materials.

## FABRIC AND PIPING

Look in Product sheet Fabric and piping.pdf for our standard fabrics, you can download it here: <http://glimakra.com/en/download/>

# Limbus Hexagon

Work booth

Design: Team Glimakra



## OPTIONS

**Tabletop Fixed 22 mm:** Veneer in ash, birch, beech and oak.

Laminate in birch, beech, oak, white, black and grey.

**Addon:** Dimensioned add on screen in acrylic plastic.

More information in separate product sheet.

**Hexagon table stand:** Height adjustable stand,

black (default), White, Grey.

- Adjustable height
- Stroke 660 mm (605 -1265 mm  $\pm$  5 mm)
- Sound level < 42 dBA
- Lifting capacity Max 100 kg
- Power consumption in standby mode 0.1 W

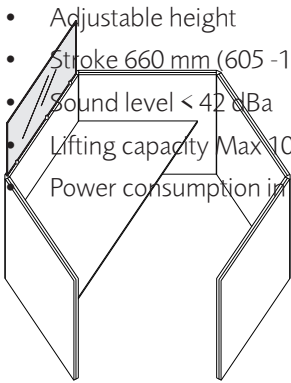

## CERTIFICATES

**Acoustics:** Measurements made in accordance with ISO 354:2003. Evaluation made according to standards for individual objects SS 25269:2013 (Report 10171560.03, Date 2012-01-30, WSP Akustik, laboratory accredited by Swedac)

**Möbelfakta:** The product meets the requirements for environment and responsible supply chains defined by Möbelfakta.

Glimakra of Sweden AB is certified according to ISO 9001:2015 and ISO 14001:2015.



## SPECIFICATION TEXT

E.g: Glimakra Limbus Hexagon formation 2.

2 x 15 mm sound absorbing polyether on both sides of an 8 mm sound reducing MDF board.

**Fabric:** Blazer CUZ 28 on the inside and Blazer CUZ 30 on the outside. No visible seams. Nails hidden by piping black 190.

Easy installation with connecting poles.

Acoustics evaluated according to SS 25269.

2 fixed tabletops in veneer 22 mm ash.

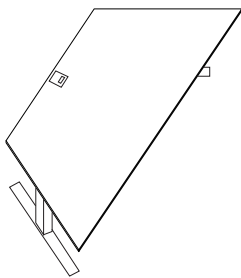

# Limbus Hexagon

Work booth

Design: Team Glimakra



Hex 1

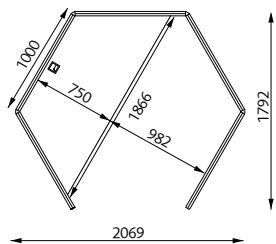

Hex 2

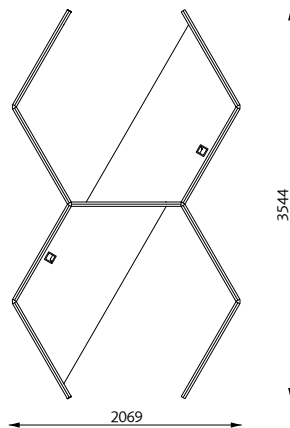

Hex 3

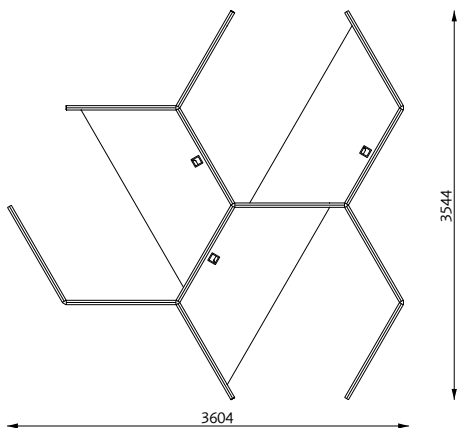

Hex 4

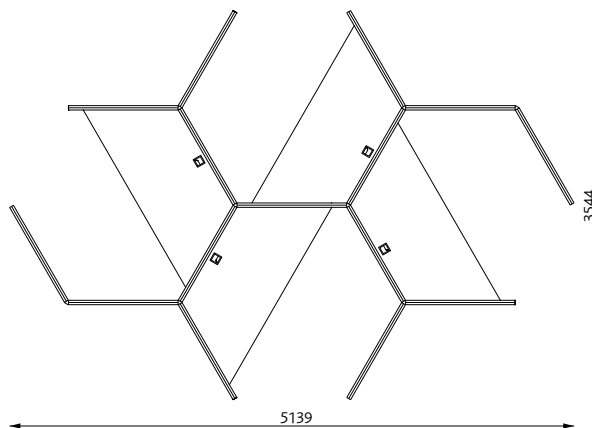

# Limbus Hexagon

Work booth

Design: Team Glimakra



GLIMAKRA  
OF SWEDEN

Hex 5

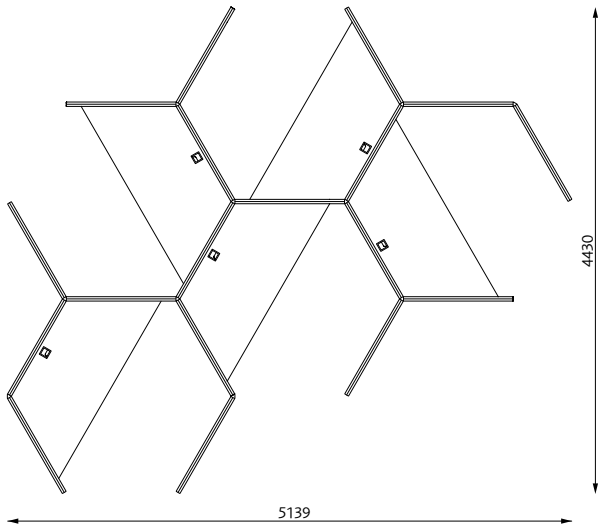

Hex 6

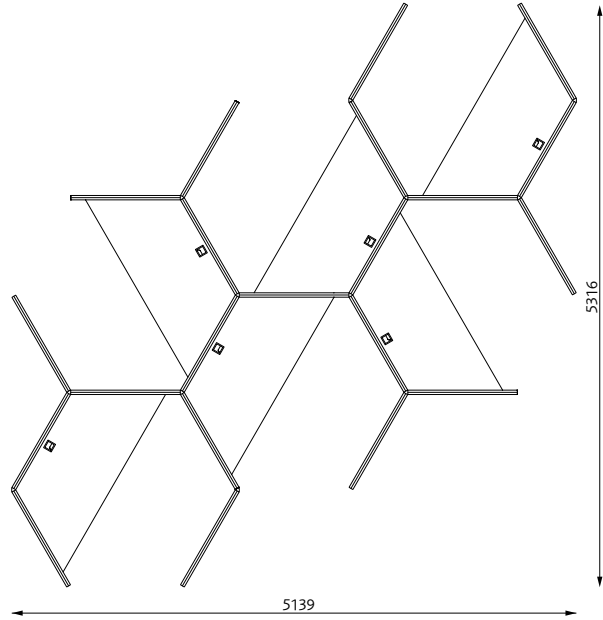

Hex 7

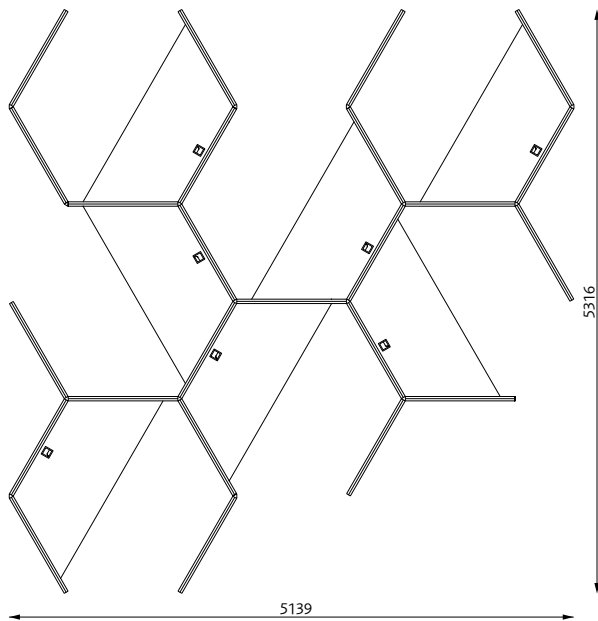

Hex 8

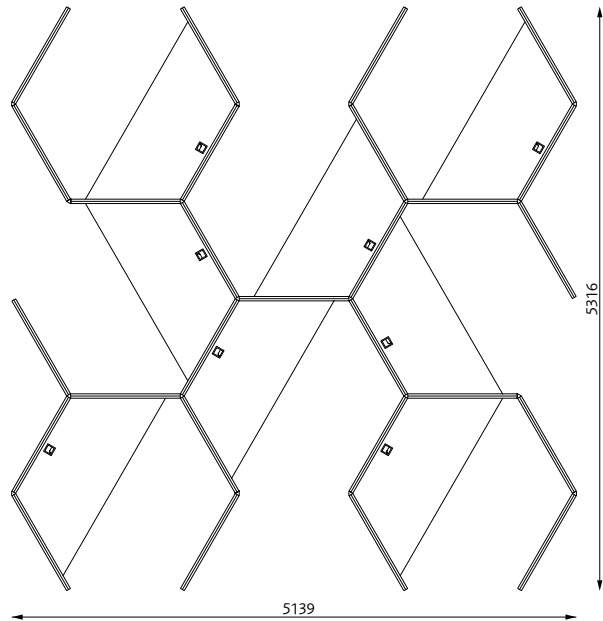

# Limbus Hexagon

Work booth

Design: Team Glimakra



## Hex 1

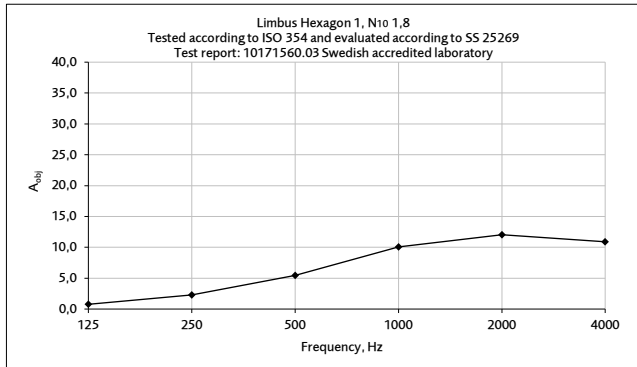

Equivalent absorption area per object (m<sup>2</sup>S/object)

## Hex 3

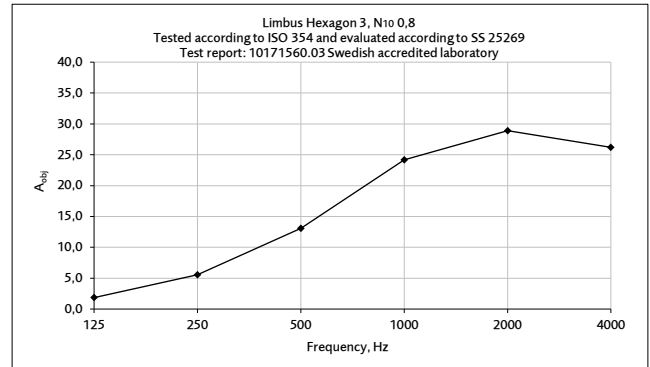

Equivalent absorption area per object (m<sup>2</sup>S/object)

## Hex 2

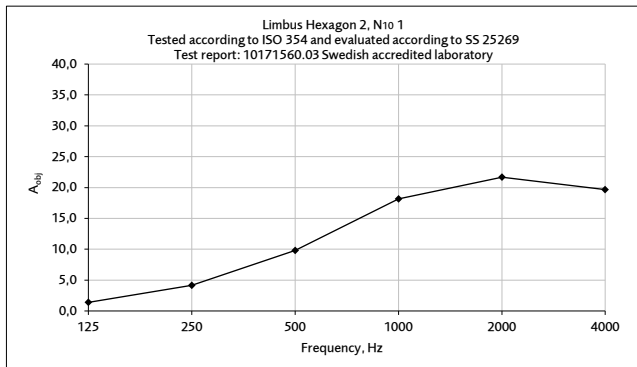

Equivalent absorption area per object (m<sup>2</sup>S/object)

## Hex 4

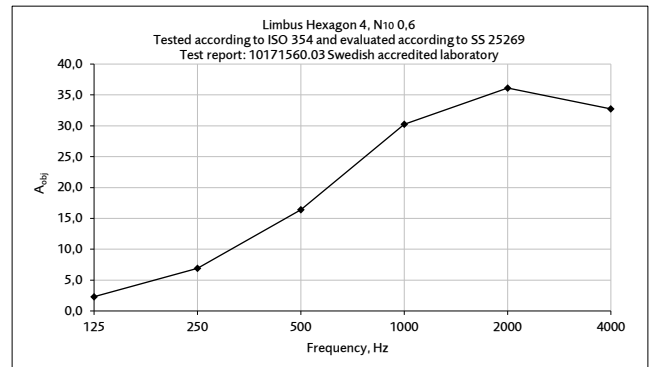

Equivalent absorption area per object (m<sup>2</sup>S/object)

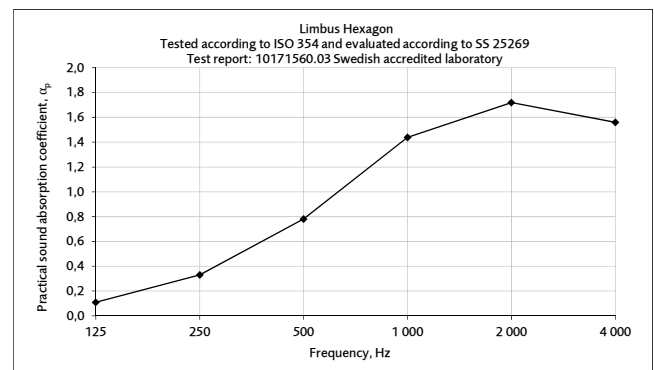

Equivalent absorption area per m<sup>2</sup> screen surface (m<sup>2</sup>S/m<sup>2</sup>)

The values are to be multiplied by the floor screen area.



# Limbus Hexagon

Work booth

Design: Team Glimakra



GLIMAKRA  
OF SWEDEN

